



FC121-ZA / FC122-ZA / FC123-ZA / FC124-ZA

Cerberus™ FIT

Fire control panel



Series FC120

- Compact, prefabricated microprocessor-controlled fire control panel
- Fire control panel can be used as stand-alone version
- 2 or 4 or 8 or 12 zones
- Compatible with the Siemens detector ranges 110-series / DS11 and Syno-LINE300 / SynoLINE600
- Integrated user-friendly operating unit
- Optional EVAC module, key switch, LED indicators
- Slots for output cards
- Emergency power supply for up to 72 h emergency power time
- Flexible programming
- Programmable alarm organization for manned/unmanned operation
- Event memory with stamped date and time
- Simple user controls via menu navigation
- Key code user access with optional key-switch alternative
- Easy on-site configuration

System overview

Detector line Cerberus 110-series
 Detector line AlgoRex DS110x
 Detector line Synova 600

Detector line Cerberus 110-series
 Synova 300

Detector line Cerberus 110-series
 with line continuity according to
 BS 5839 Pt1

Call point line

Mixed line (detector/call point with
 differentiation)

Linear smoke detector or flame
 detector

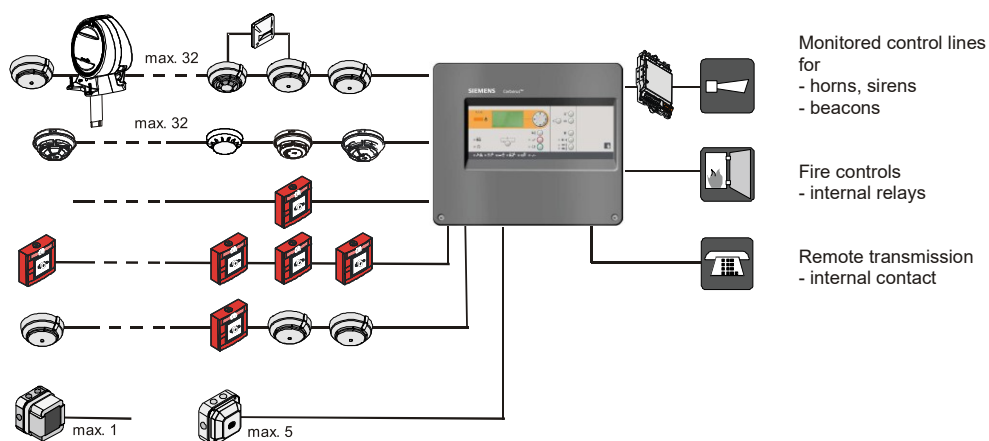

Various panel types with different features

Types	Zones	Monitored outputs	Relay outputs	Output cards	Power supply	Battery
FC121-ZA	2	2	1	1	25 W	Max. 7 Ah
FC122-ZA	4	2	1	1	25 W	Max. 7 Ah
FC123-ZA	8	2	1	2	70 W	Max. 17 Ah
FC124-ZA	12	2	1	3	70 W	Max. 17 Ah

Functional elements

The FC121-ZA, FC122-ZA, FC123-ZA, FC124-ZA are compact fire control panels with an integrated operating unit for 2 or 4 or 8 or 12 zones.

Processes signals from the 110-series / DS11 and SynoLINE300/600 series.

The control unit has been designed to be very simple to use while offering exceptional flexibility via a comprehensive feature list.

- All detector lines are monitored for ground faults.
- Adaptation of the customer text directly on the panel via menu navigation.
- Up to 1000 events can be stored according to various criteria.
- Automatic summer/winter time change.

Detection

- Each line supports 110-series / DS11 and SynoLINE300/600 series devices
- Detectors and call points on same line with functional differentiation (where allowed)



Max. load of devices per line is 32.

See List of compatibility (A6V10393192).

Inputs / Outputs

FC121, FC122

- 2 monitored control lines 24 V / 500 mA for horns, fire controls, external remote transmission.
- 1 dry output 30 V / 1 A
- 2 programmable control inputs

FC123, FC124

- 2 monitored control lines 24 V / 500 mA for horns, fire controls, external remote transmission.
- 1 dry output 30 V / 1 A
- 3 programmable control inputs

Extensions

- Up to 6 monitored control lines 24 V / 1 A for horns, fire controls, external remote transmission (depending on the panel type).
- Up to 6 dry outputs 30 V / 1 A (depending on the panel type).

PMI

- Individual customer text for each zone
- User friendly operation via menu navigation

Commissioning

- Basic functions that can be adapted on-site if required without laptop
- Simple start up with preset default values
- Service function to view date and time of last alarm

Functional elements

Operating unit

The following are located on the operating unit:

- CPU module and the electronics for the operating unit
- Power supply
- Additional connection terminals for accessories
 - 'Nordic SE' key switch
 - LED display 12 x 2 LED
 - EVAC Module
 - Output card

Power supply 25 W and 70 W, emergency power supply

The power supply supplies the hardware and charges the batteries.

- The batteries supply the emergency power in case of power failure.











Configuration

For an easy configuration on site via integrated display no additional equipment is required.

Application ranges

The FC120 is ideally suited for small applications, e.g.: in schools, small shops, hotels, etc.

Overview of FC121-ZA, FC122-ZA, FC123-ZA, FC124-ZA

FC121-ZA & FC122-ZA		FC123-ZA & FC124-ZA	
FC121-ZA	FC122-ZA	FC123-ZA	FC124-ZA
			
2 zones With power supply (25 W) Battery capacity 4 or 7 Ah	4 zones With power supply (25 W) Battery capacity 4 or 7 Ah	8 zones With power supply (70 W) Battery capacity 7, 12 or 17 Ah	12 zones With power supply (70 W) Battery capacity 7, 12 or 17 Ah
Expansion		Expansion	
FCA1203-Z1	FTO1201-H1	FTO1203-H1	FTO1202-Z1
Output card 2M 2R 	EVAC module (NL 2&4 Z) 	EVAC module (NL 8&12 Z) 	Zone ind. field 12x2 LED 
2 monitored outputs 24 V / 1 A 2 relay outputs 30 V / 1 A	EVAC module for NL With 1 EVAC zone	EVAC module for NL With 1 EVAC zone	with each one red + yellow LED
Accessories FC12x-ZA			
FCA1206-Z1	FCA1209-Z1	FP120-Z1	
Key switch set (Nordic SE) 	Output module (230 V) 	Power supply kit A 70 W 	
Key switch for access level II	Relay output 230 V / 5 A For the activation of external equipment	Additional power supply 70 W	

Configuration of FC121-ZA and FC122-ZA

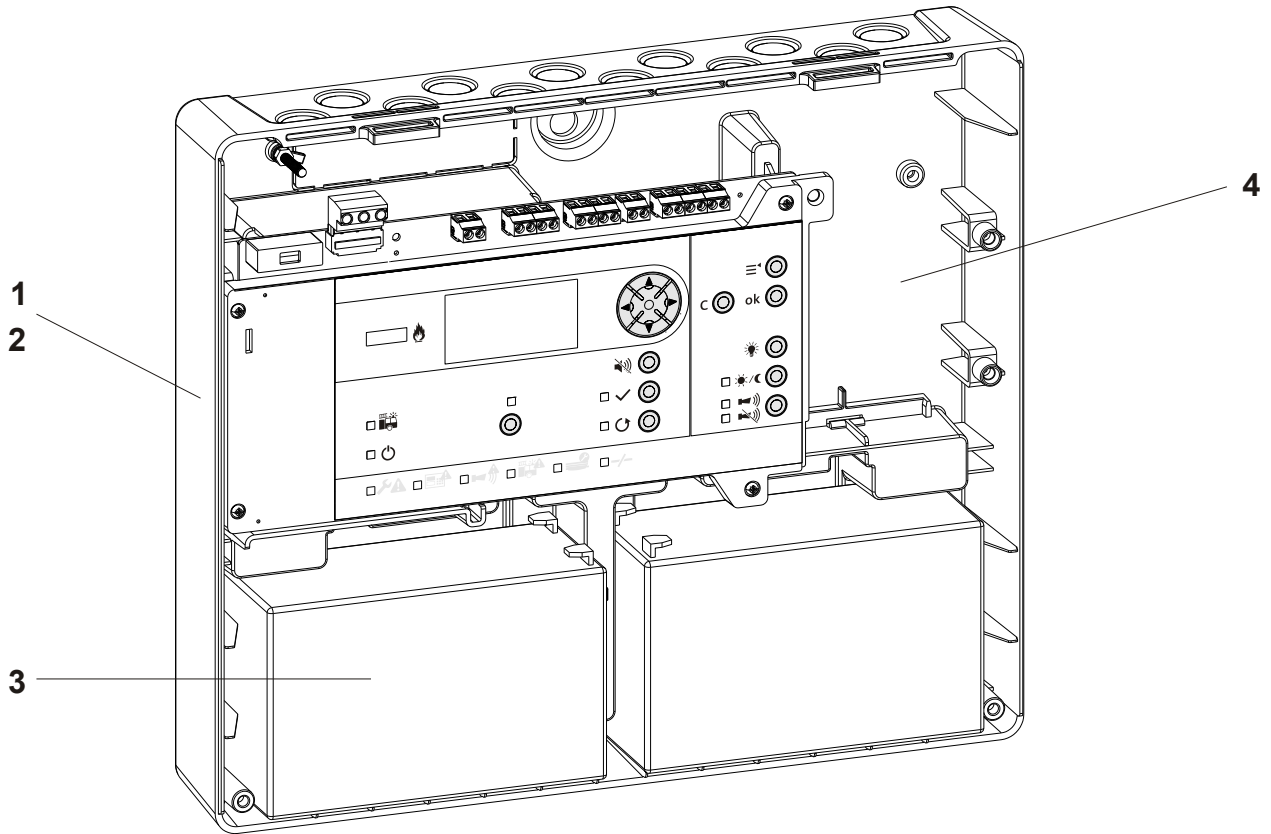

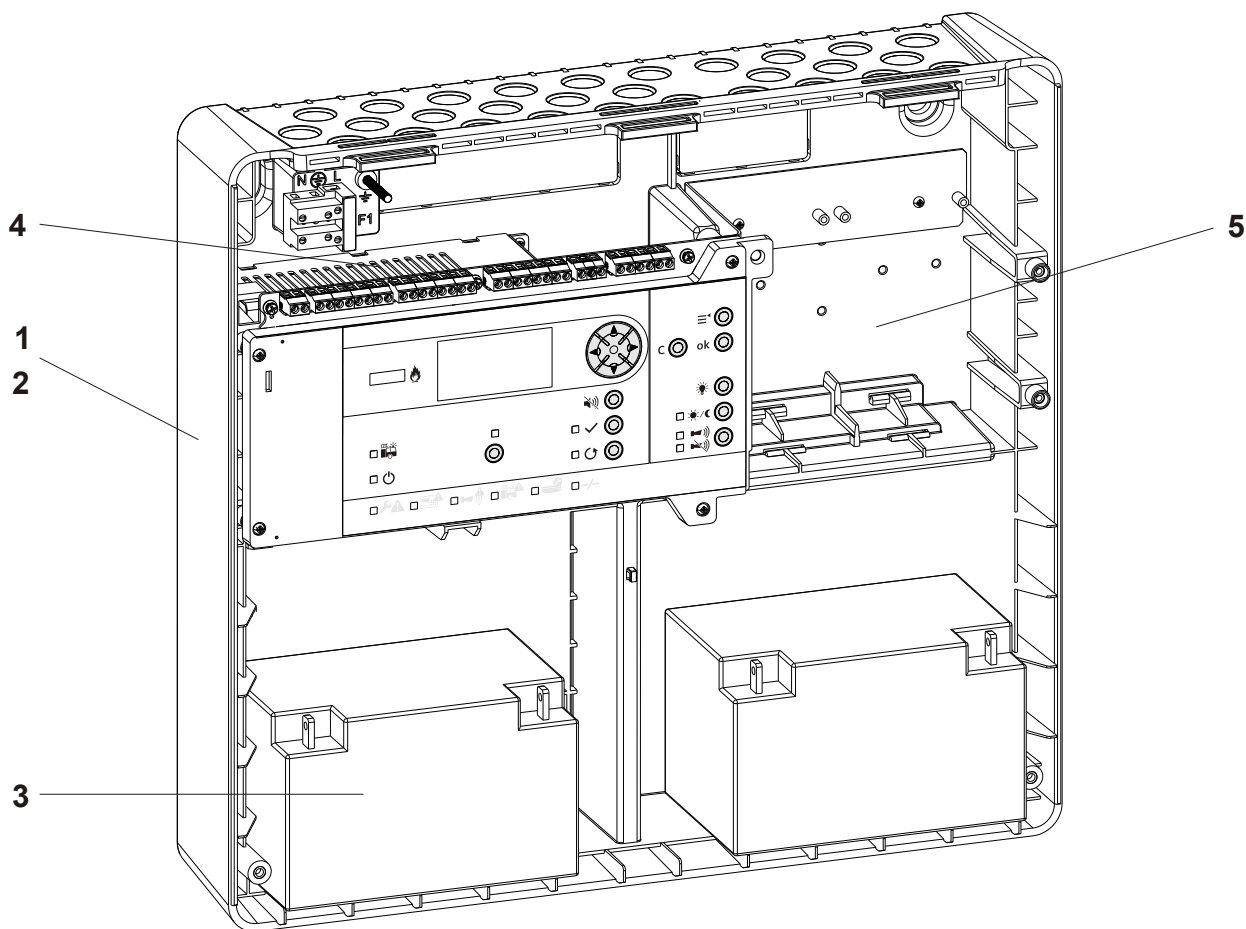

Basic equipment		Designation	Notes
1	Control panel with - Power supply - Main board	FC121-ZA	2 zones
2	Control panel with - Power supply - Main board	FC122-ZA	4 zones
3	Battery (12 V, 4 Ah, VDS) Battery (12 V, 7 Ah, VDS)	AX1213 FA2003-A1	For emergency power supply
4	Slot for expansions	-	Space for expansion A, B, C
Expansion			
A	Output card 2M 2R	FCA1203-Z1	2 monitored outputs 2 relay outputs
B	EVAC module (NL 2&4 zones)	FTO1201-H1	Expansion C is not possible
C	Key switch (Nordic SE)	FCA1206-Z1	Expansion B is not possible

Configuration of FC123-ZA and FC124-ZA



Basic equipment	Designation	Notes
1 Control panel with - Power supply - Main board	FC123-ZA	8 zones
2 Control panel with - Power supply - Main board	FC124-ZA	12 zones
3 Battery (2 x 12 V, 7 Ah, VDS)	FA2003-A1	For emergency power supply
Battery (2 x 12 V, 12 Ah, VDS)	FA2004-A1	
Battery (2 x 12 V, 17 Ah, VDS)	FA2005-A1	
4 Power supply 70 W	FP2015-A1	
5 Slot for expansions		Space for expansion A, B, C, D
Expansion		
A Output card 2M 2R	FCA1203-Z1	FC123: max. 2 additional cards FC124: max. 3 additional cards
B Zone ind. Field 12x2 LED	FTO1202-Z1	Expansion C, D are not possible
C EVAC module (NL 8&12 zones)	FTO1203-H1	Expansion B, D are not possible
D Key switch (Nordic SE)	FCA1206-Z1	Expansion B, C are not possible

Disposal

 	<p>The device is considered electrical and electronic equipment for disposal in terms of the applicable European Directive and may not be disposed of as domestic garbage.</p> <ul style="list-style-type: none">• Dispose of the device through channels provided for this purpose.• Comply with all local and currently applicable laws and regulations.• Dispose of empty batteries in designated collection points.
--	---

Batteries

	<p>⚠ WARNING</p> <p>Switching batteries in parallel</p> <p>Risk of explosion and fire</p> <ul style="list-style-type: none">• Never connect batteries in parallel!• If you need more power, you must use batteries with a higher capacity.
---	---

Technical data

	FC121-ZA	FC122-ZA	FC123-ZA	FC124-ZA
Mains voltage	AC 196...253 V		AC 97...127 V AC 196...253 V	
Power consumption	25 W		70 W	
Operating voltage	DC 21...28.6 V			
Max. nominal output current without battery charging (I max b)	Max. 0.9 A		Max. 2.5 A	
Battery capacity	2x 12 V, up to 7 Ah		2x 12 V, up to 17 Ah	
Battery monitoring	Yes		Yes	
Mains monitoring	Yes		Yes	
Connectable detector series	110-series / DS11 / SynoLINE300/600			
Number of lines	2	4	8	12
Number of detectors per line	Max. 32			
Integrated inputs/outputs				
– Monitored outputs				
– RT Alarm	1x 24 V / 0.5 A		1x 24 V / 1 A	
– Horn	1x 24 V / 0.5 A		1x 24 V / 1 A	
– Dry contact				
– RT fault	30 V / 1 A		30 V / 1 A	
– Free programmable inputs/outputs	2		3	
Slots for relay cards	1		2	3
Emergency current	Up to 72 Ah			
Operating temperature	-5...+40 °C			
Storage temperature	-20...+60 °C			
Humidity (no condensation permitted)	≤95 % rel.			
Dimensions (W x H x D)	360 x 310 x 85 mm		430 x 399 x 124 mm	
Color				
– Housing and Cover	Grey, ~RAL 000 50 00			
Protection category (IEC 60529)	IP30		IP30	

14  2831	FC121-ZA / FC122-ZA	Siemens Schweiz AG; Theilerstrasse 1a CH-6300 Zug Technical data: see doc. A6V10393190
FC121 / FC122 - Control and Indicating Equipment incl. 25W/24VDC Power Supply Equipment for use in fire detection and fire alarm systems installed in buildings.		
305/2011/EU (CPR): EN 54-2 / EN 54-4 ; 2014/30/EU (EMC): EN 50130-4 / EN 61000-6-3 ; 2014/35/EU (LVD): EN 60950-1 ; 2011/65/EU (RoHS): EN 50581		
The declared performance and conformity can be seen in the Declaration of Performance (DoP) and the EU Declaration of Conformity (DoC), which is obtainable via the Customer Support Center: Tel. +49 89 9221-8000 or http://siemens.com/bt/download		
DoP No.: DOP190201; DoC No.: CED-FC121-FC122		

14  2831	FC123-ZA / FC124-ZA	Siemens Schweiz AG; Theilerstrasse 1a CH-6300 Zug Technical data: see doc. A6V10393190
FC123 / FC124 - Control and Indicating Equipment incl. FP2015 - 70W/24VDC Power Supply Equipment for use in fire detection and fire alarm systems installed in buildings.		
305/2011/EU (CPR): EN 54-2 / EN 54-4 ; 2014/30/EU (EMC): EN 50130-4 / EN 61000-6-3 ; 2014/35/EU (LVD): EN 60950-1 ; 2011/65/EU (RoHS): EN 50581		
The declared performance and conformity can be seen in the Declaration of Performance (DoP) and the EU Declaration of Conformity (DoC), which is obtainable via the Customer Support Center: Tel. +49 89 9221-8000 or https://siemens.com/bt/download		
DoP No.: DOP190210; DoC No.: CED-FC123-FC124		

Details for ordering

	Type	Part no	Designation	Weight
Fire control panels	FC121-ZA	S54400-C131-A1	Fire control panel (2Z)	1.840 kg
	FC122-ZA	S54400-C130-A1	Fire control panel (4Z)	1.845 kg
	FC123-ZA	S54400-C129-A1	Fire control panel (8Z)	4.113 kg
	FC124-ZA	S54400-C128-A1	Fire control panel (12Z)	4.128 kg
Expansion	FCA1203-Z1	S54400-B142-A1	Output card 2M 2R	0.064 kg
	FTO1202-Z1	S54400-B119-A1	Zone ind. Field 12x2 LED	0.125 kg
	FTO1203-H1	S54400-B118-A1	EVAC module (NL 8&12 Z)	0.112 kg
	FTO1201-H1	S54400-B120-A1	EVAC module (NL 2&4 Z)	0.074 kg
	FCA1209-Z1	S54400-B124-A1	Output module (230 V)	0.068 kg
	FCA1206-Z1	S54400-S125-A1	Key switch set (Nordic SE)	0.065 kg
Power supply	FP120-Z1	S54400-S122-A1	Power supply kit A 70 W	3.920 kg
Batteries	AX1213	4392990001	Battery 4 Ah	1.665 kg
	FA2003-A1	A5Q00019353	Battery (12 V, 7 Ah, VDS)	2.450 kg
	FA2004-A1	A5Q00019354	Battery (12 V, 12 Ah, VDS)	3.930 kg
	FA2005-A1	A5Q00019677	Battery (12 V, 17 Ah, VDS)	5.640 kg
Spare part	FP2015-A1	S54400-B121-A1	Power supply (70 W)	0.575 kg

Issued by
Siemens Switzerland Ltd
Smart Infrastructure
Global Headquarters
Theilerstrasse 1a
CH-6300 Zug
+41 58 724 2424
www.siemens.com/buildingtechnologies

© Siemens Switzerland Ltd, 2012
Technical specifications and availability subject to change without notice.